

## Operating Instruction and Safety Manual

### Electric Airless Sprayer

Model No.:  R450 220V  R455 120V

—For portable spray application of architectural paints and coatings



#### Important Safety Instructions:

Read all warnings and instructions in this manual. Save these instructions.



#### Warning

1. Must be grounded: Read Grounding instructions. Use only grounded electrical outlets or Ground equipment and conductive objects in work area.
2. Have heart problem or with heart pacemaker people, strictly prohibit to use this machine.

◎ Important safety instructions.....	2~3
◎ Technical Data.....	3
◎ Warning .....	4~7
◎ Component Identification.....	7
◎ Installation.....	7~10
◎ Pressure Relief Procedure.....	10~11
◎ Operation instruction.....	11~13
◎ Airless Sprayer Cleaning Procedure.....	13
◎ Pressure release procedure.....	13
◎ Daily Maintain.....	13
◎ General Repair Information.....	14
◎ Troubleshooting.....	15
◎ Parts List.....	16-18
◎ Sealing ring replace.....	18
◎ Airless Sprayer Electrical Installation Drawing.....	23

## ※ IMPORTANT SAFETY INSTRUCTIONS

INSTRUCTIONS PERTAINING TO A RISK OF FIRE, ELECTRIC SHOCK, OR INJURY TO PERSONS

**WARNING – When using tools, basic precautions should always be followed, including the following:**

- a) SAVE THESE INSTRUCTIONS-To reduce the risks of fire or explosion, electrical shock and injury to persons, read and understand all instructions included in this manual. Be familiar with the controls and the proper usage of the equipment.
- b) WARNING-To reduce the risk of fire of explosion:
  - 1) Do not spray flammable or combustible materials near an open flame or sources of ignition such as cigarettes, motors, and electrical equipment.
  - 2) For units intended for use with only water-based materials-Do not spray or clean with flammable liquids. For use with water-based liquids only.
  - 3) For units intended for use with only water-based or mineral spirit-type materials with a minimum flash point of 21C°(69.8 F°) Do not spray on clean with liquids having a flash point less than 21C°(69.8 F°)
  - 4) Paint or solvent flowing through the equipment is able to result in static electricity. Static electricity creates a risk of fire or explosion in the presence of paint or solvent fumes. All parts of the spray system, including the pump, hose assemble, spray gun, and objects in and around the spray area shall be properly grounded to protect against static discharge and sparks. Use only conductive or grounded high-pressure airless paint sprayer hoses specified by the manufacturer.
  - 5) Verify that all containers and collection systems are grounded to prevent static discharge.
  - 6) Connect to a grounded outlet and use grounded extension cords. Do not use a 3 to 2 adapter.
  - 7) Do not use a paint or a solvent containing halogenated hydrocarbons. See operating instructions for examples of these types of materials.
  - 8) Keep spray area well ventilated. Keep a good supply of fresh air moving through the area. Keep pump assembly in a well ventilated area. Do not spray pump assembly.
  - 9) Do not smoke in the spray area.
  - 10) Do not operate light switches, engines, or similar spark producing products in the spray area.
  - 11) Keep area clean and free of paint or solvent containers, rags, and other flammable materials.
  - 12) Know the contents of the paints and solvents being sprayed. Read all Material safety Data Sheets (MSDS) and container labels provided with the paints and solvents. Follow the paint and solvent manufacturer's safety instructions.
  - 13) Fire extinguisher equipment shall be present and working.
- c) WARNING-To reduce the risk of skin injection.
  - 1) Do not aim the gun at, or spray any person or animal.

- 2) Keep hands and other body parts away from the discharge. For example, do not try to stop leaks with any part of the body.
  - 3) Always use the nozzle tip guard. Do not spray without nozzle tip guard in place.
  - 4) Only use a nozzle tip specified by the manufacturer.
  - 5) Use caution when cleaning and changing nozzle tips. In the case where the nozzle tip clogs while spraying, follow the manufacturer's instructions for turning off the unit and relieving the pressure before removing the nozzle tip to clean.
  - 6) Do not leave the unit energized or under pressure while unattended. When the unit is not in use, turn off the unit and relieve the pressure in accordance with the manufacturer's instructions.
  - 7) High-pressure spray is able to inject toxins into the body and cause serious bodily injury. In the event that injection occurs, seek medical attention immediately.
  - 8) Check hose and parts for signs of damage. Replace and damaged hoses of parts.
  - 9) This system is capable of producing 20.7Mpa. Only use replacement parts or accessories that are specified by the manufacturer and that are rated a minimum of 22.8Mpa.
  - 10) Always engage the trigger lock when not spraying. Verify the trigger lock is functioning properly.
  - 11) Verify that all connections are secure before operating the unit.
  - 12) Know how to stop the unit and bleed pressure quickly. Be thoroughly familiar with the controls.
- d) **WARNING-To reduce the risk of injury.**
- 1) Always wear appropriate gloves, eye protection, and a respirator or mask when painting.
  - 2) Do not operate or spray near children. Keep children away from equipment at all times.
  - 3) Don not overreach or stand on an unstable support. Keep effective footing and balance at all times.
  - 4) Stay alert and watch what you are doing.
  - 5) Do not operate the unit when fatigued or under the influence of drugs or alcohol.
  - 6) Do not kink or over-bend the hose.
  - 7) Do not expose the hose to temperatures or to pressures in excess of those specified by the manufacturer.
  - 8) Do not use the hose as a strength member to pull or lift the equipment.
  - 9) The Max. pressure of the air hose is 22.8Mpa, the normal pressure is 20.7Mpa
  - 10) The paint can be compatible: phenol aldehyde paint series, nitryl paint series, alkyd paint series, epoxy resin paint series, oxidized rubber paint series, latex paint series, water soluble paint series. The paint should be put in shade and dry place.
  - 11) Be aware of any hazards presented by the material being sprayed and consult the markings on the container or information supplied by the manufacturer of the material to be sprayed, including requirements for the use of personal protective equipment.
  - 12) Do not spray any material there the hazard is not know.



## Technical Data

TYPE:	R450	R455
Power requirements	230±10%Vac, 50±1Hz	110±10%Vac, 60±1Hz
Input power	1.2HP(900W)	1.2HP(900W)
Maximum working pressure	3000PSI	3000PSI
Sound pressure level:	73.9 db	73.9 db
Vibration value:	2.84 m/ss	2.84 m/ss
Maximum delivery gpm (lpm)	2.2LPM/0.58GPM	2.2LPM/0.58GPM
Working environment temperature requirement:	5°C~40°C	5°C~40°C
Working environment humidity requirement:	30%~95%	30%~95%
Working environment altitude requirement:	≤1000m	≤1000m
Transportation and storage temperature requirement:	25°C~55°C	25°C~55°C
Dimensions Weight	14.5kg	14.5kg



# Warning

The following warnings are for the setup, use, grounding, maintenance and repair of this equipment. The exclamation point symbol alerts you to a general warning and the hazard symbol refers to procedure-specific risks. Refer back to these warnings. Additional, product-specific warnings may be found throughout the body of this manual where applicable.

	<p><b>FIRE AND EXPLOSION HAZARD</b></p> <p>Flammable fumes, such as solvent and paint fumes, in work area can ignite or explode. To help prevent fire and explosion:</p> <ul style="list-style-type: none"> <li>• Use equipment only in well ventilated area.</li> <li>• Eliminate all ignition sources; such as pilot lights, cigarettes, portable electric lamps, and plastic drop cloths (potential static arc).</li> <li>• Sprayer generates sparks. When flammable liquid is used in or near the sprayer or for flushing or cleaning, keep sprayer at least 20 feet (6 m) away from explosive vapors.</li> <li>• Keep work area free of debris, including solvent, rags and gasoline.</li> <li>• Do not plug or unplug power cords or turn lights on or off when flammable fumes are present.</li> <li>• <b>Ground equipment and conductive objects in work area. Read Grounding instructions.</b></li> <li>• If there is static sparking or you feel a shock, <b>stop operation immediately.</b> Do not use equipment until you identify and correct the problem.</li> <li>• Keep a working fire extinguisher in the work area.</li> </ul>
	<p><b>ELECTRIC SHOCK HAZARD</b></p> <p>Improper grounding, setup, or usage of the system can cause electric shock.</p> <ul style="list-style-type: none"> <li>• Turn off and disconnect power cord before servicing equipment.</li> <li>• <b>Use only grounded electrical outlets.</b></li> <li>• Use only 3-wire extension cords.</li> <li>• Ensure ground prongs are intact on sprayer and extension cords.</li> <li>• Do not expose to rain. Store indoors.</li> </ul>
	<p><b>SKIN INJECTION HAZARD</b></p> <p>High-pressure fluid from gun, hose leaks, or ruptured components will pierce skin. This may look like just a cut, but it is a serious injury that can result in amputation. <b>Get immediate surgical treatment.</b></p> <ul style="list-style-type: none"> <li>• Do not point gun at anyone or at any part of the body.</li> <li>• Do not put your hand over the spray tip.</li> <li>• Do not stop or deflect leaks with your hand, body, glove, or rag.</li> <li>• Engage trigger lock when not spraying.</li> <li>• Follow <b>Pressure Relief Procedure</b> in this manual, when you stop spraying and before cleaning, checking, or servicing equipment.</li> </ul>



# WARNING



## EQUIPMENT MISUSE HAZARD

Misuse can cause death or serious injury.

- Do not exceed the maximum working pressure or temperature rating of the lowest rated system component. Read **Technical Data** in all equipment manuals.
- Use fluids and solvents that are compatible with equipment wetted parts. Read **Technical Data** in all equipment manuals. Read fluid and solvent manufacturer's warnings. For complete information about your material, request MSDS from distributor or retailer.
- Check equipment daily. Repair or replace worn or damaged parts immediately with manufactory replacement parts only.
- Do not alter or modify equipment.
- Use equipment only for its intended purpose. Call your distributor for information.
- Route hoses and cables away from traffic areas, sharp edges, moving parts, and hot surfaces.
- Do not kink or over bend hoses or use hoses to pull equipment.
- Comply with all applicable safety regulations.
- Keep children and animals away from work area.
- Do not operate the equipment when fatigued or under the influence of drugs or alcohol.



## PRESSURIZED ALUMINUM PARTS HAZARD

Do not use 1, 1, 1-trichloroethane, ethylene chloride, other halogenated hydrocarbon solvents or fluids containing such solvents in pressurized aluminum equipment. Such use can cause serious chemical Reaction and equipment rupture, and result in death, serious injury, and property damage.



## BURN HAZARD

Equipment surfaces can become very hot during operation. To avoid severe burns, do not touch hot equipment. Wait until equipment has cooled completely.



## MOVING PARTS HAZARD

Moving parts can pinch or amputate fingers and other body parts.

- Keep clear of moving parts.
- Do not operate equipment with protective guards or covers removed.
- Pressurized equipment can start without warning. Before checking, moving, or servicing equipment, follow the **Pressure Relief Procedure** in this manual. Disconnect power or air supply.



## **TOXIC FLUID OR FUMES HAZARD**

Toxic fluids or fumes can cause serious injury or death if splashed in the eyes or on skin, inhaled, or swallowed.

- Read warnings to know the specific hazards of the fluids you are using.
- Store hazardous fluid in approved containers, and dispose of it according to applicable guidelines.



## **PERSONAL PROTECTIVE EQUIPMENT**

You must wear appropriate protective equipment when operating, servicing, or when in the operating area of the equipment to help protect you from serious injury, including eye injury, inhalation of toxic fumes, burns, and hearing loss.

This equipment includes but is not limited to:

- Protective eye wear
- Clothing and respirator as recommended by the fluid and solvent manufacturer
- Gloves
- Hearing protection

## **Special Focus**

- A) Forbidden use of machines which are not designed for potentially explosive atmospheres
- B) Use of electrostatic atomizing and spraying equipment with machines not specially designed for this equipment, because it may result in serious hazards for the operators
- C) Hazards resulting from contact with and/or breathing of toxic materials, gases, mists and vapours which may be created by operation of the machine. Such warnings shall also include such regarding the use of personal protective equipment and reminding the user to be aware of the recommendations of the coating material manufacturer;
- D) Surface temperatures of any part of the machine, reachable during normal operation, maintenance and servicing but not normally in contact with the human body, which can exceed 48°C or be less than 0°C.
- E) Pressurised coating material and /or compressed air not to be directed towards persons or animals;
- F) Relating to training for the safe operation, adjustment, cleaning and maintenance of the machine;
- G) Regarding any special earthing measures;
- H) Stating that a list of the materials used in the construction of the machine will be made available on request to validate the compatibility with the coating materials being used;
- I) Regarding the requirements of using the machine only in a well ventilated area with regards to health, fire and explosion risks;
- J) Regarding the visually inspection for damage on hoses which may be subjected to friction
- K) Requirements for environmental protection to be observed
- L) Reduce the quantity of coating and/or auxiliary materials at workplaces to a minimum

## **Special Attention:**

- a) Maximum allowable pressure for the coating material..... 20.7 Mpa (3000psi)
- b) Typical coating material flow rate for sample conditions: 2.1L/Min
- c) Type and use of any safety devices in the machine:
  1. Temperature control device
  2. Maximum pressure control device
  3. Maximum electrical current control device
  4. Creepage protect control device
  5. Hand-hurt protect device

## Component Identification



Number	Description	Function Introduction
01	Pressure Adjust Knob	Control output pressure of Paint(Clockwise increase pressure, anticlockwise decrease pressure)
02	Electrical Switch	Control the sprayer on or off
03	Pressure Relief Valve	Horizontal direction means the paint operating condition, Vertical direction means paint pressure relief condition
04	Fluid Outlet	Paint Output Tube
05	Suction Tube	Absorb the paint from the container to sprayer
06	Drain Hose	When pressure relief, the paint flow from this tube

## INSTALLATION:

### Grounding and Electric Requirements



#### Grounding Instructions

**This product must be grounded.** In the event of an electrical short circuit, grounding reduces the risk of electric shock by providing an escape wire for the electric current. This product is equipped with a cord having a grounding wire with an appropriate grounding plug. The plug must be plugged into an outlet that is properly installed and grounded in accordance with all local codes and ordinances.

Improper installation of the grounding plug can result in a risk of electric shock.

If repair or replacement of the cord or plug is necessary, do not connect the green grounding wire to either flat blade terminal. The wire with insulation having a green outer surface with or without yellow stripes is the grounding wire and must be connected to the grounding pin. Check with a qualified electrician or serviceman if the grounding instructions are not completely understood, or if you are in doubt as to whether the product is properly grounded. Do not modify the plug provided. If the plug will not fit the outlet, have the proper outlet installed by a qualified electrician.

**The sprayer cord includes a grounding wire with an appropriate grounding contact.**

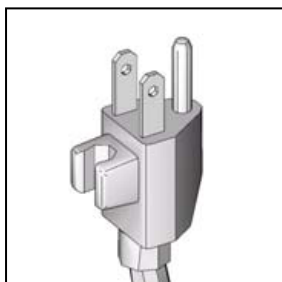

**The sprayer requires for type 475:**  
100-120Vac, 50 Hz, 11A, 1 phase,  
circuit with a grounding receptacle

**The sprayer requires for type 470:**  
220-240Vac, 50Hz, 11A, 1 phase, circuit  
with a grounding receptacle.

**Never use an outlet that is not grounded or an adapter.**

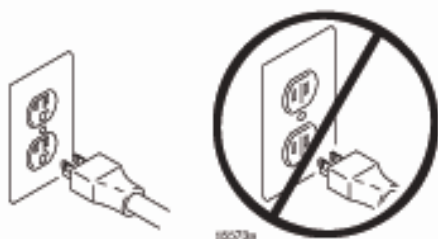

**Do not use the sprayer if the electrical cord has a damaged ground contact. Only use an extension cord with an undamaged ground contact.**



Smaller gauge or longer extension cords may reduce sprayer performance.

**Spray gun:** ground through connection to a properly grounded fluid hose and pump.

**Fluid supply container:** follow local code.

**Solvent and Oil-based fluids:** follow local code. Use only conductive metal pails placed on a grounded surface such as concrete. Do not place the pail on a nonconductive surface such as paper or cardboard, which interrupts grounding continuity.

**Grounding the metal pail:** Connect a ground wire to the pail by clamping one end to pail and other end to ground such as a water pipe.



**To maintain grounding continuity when flushing or relieving pressure:** hold metal part of the spray gun firmly to the side of a grounded metal pail, then trigger the gun.



### **Locking and Unlocking the Spray Gun:**



Always lock the trigger off when attaching the spray tip or when the spray gun is not in use.

#### **Locking the Spray Gun**

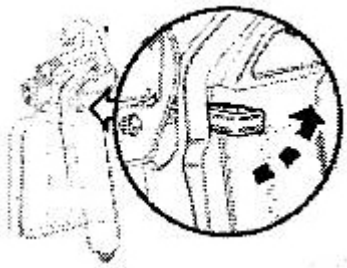

The gun is secured when the trigger lock is at a 90° angle (perpendicular) to the trigger in either direction

Applicable for wall painting paint, clean with water.

#### **Unlocking the Spray Gun**

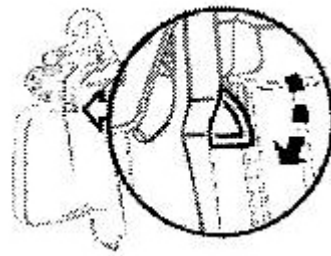

To unlock the gun, turn the trigger lock to be in the line with trigger

### **Electrical bonding**



A hose, hose assembly, and spray gun assembly shall be constructed to provide electrical bonding to dissipate static electricity from the tip of the Spray gun through the spray gun assembly and the couplings at the ends of the hose to

the pump assembly. The spray gun assembly shall also provide an external means to dissipate static electricity during the cleaning process when spraying into a metal container.

#### Construction

Black hose is constructed of an extruded, seamless thermoplastic inner tube, chemically bonded to multi-layers of high tensile synthetic resistant polyurethane cover. A static drain element of flexible, electrically conductive material is located between the braid layers.

## FEATURES

- Polyurethane cover permits greater flexibility and tighter bends
- Resistant to flex fatigue
- Dissipates static charge
- Will not swell or degrade in contact with most paint chemicals, oils and most other solvents
- Light weight- approximately half that of comparable rubber or wire hose
- O.D smaller than comparable rubber hose without reducing the I.D., pressure rating, or fluid-carrying capacity
- Highly abrasion resistant
- Extremely durable

## Pressure Relief Procedure



Follow this **Pressure Relief Procedure** whenever you are instructed to relieve pressure, stop spraying, check or service equipment or install or clean spray tip.

1. Turn OFF power and turn pressure control to lowest pressure setting.
2. Hold gun against side of grounded metal flushing pail. Trigger gun to relieve pressure.



3. Turn prime valve down. Our pressure relief should be operate by hand.

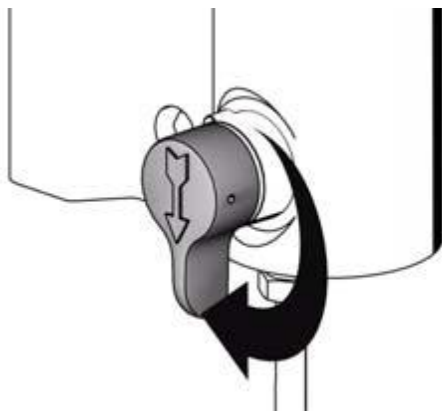

4. If you suspect the spray tip or hose is clogged or that pressure has not been fully relieved after following the steps above, **VERY SLOWLY** loosen tip guard retaining nut or hose end coupling to relieve pressure gradually, then loosen completely. Clear hose or tip obstruction.

5. Engage trigger safety lock on gun if unit is being shut down or left unattended.

## Operating Instructions

### BEFORE STARTING

**(1) CHECK** all fittings and connections in the pump system, hose, and gun to ensure that they are tight.

**CHECK** to ensure that there is a spray tip in the gun, and that the tip is the correct size for the coating you are to spray. (There are various tips available, for each type of coating or configuration.)

**(2) MAKE SURE** the power source is securely grounded and match the motor rating of your sprayer.

**(3) New spray:** Oil is used by the factory for testing and protection. It is necessary to flush unit before spraying. Clean the pump with warm soapy water, Make sure the hydraulic oil in the pump is clean and sufficient in volume then begin the following procedure

1. Remove spray tip from gun

2. Put the input hose and pressure relief tube into the bucket with some water,

3. Turn on the motor and push the pressure valve upright. In a few seconds, water will begin to flow up through the tube and flow out from outlet valve, tighten the outlet valve deasil, then tighten the pressure valve deasil.

4. When the pressure reaches up to around 207bar, check if there is any leakage on the outlet hose, if it's leak, Please check. Don't stop or deflect leaks with your hand, body, glove or rag.

5. If doesn't leak, open the spray gun and have a testing spray. Clean the oil in pump. Change the soapy water and use clean water when the spray is clean

6. Turn off power, Continue to spray till no water out.

7. Unlock trigger lock. Put the pressure valve upright, till no soapy water in pump

## Operation

### Setup



#### WARNING

Make sure sprayer is turned off and unplugged from power source.

### Connect Gun to Sprayer

1. Connect supply hose to sprayer fluid outlet.

2. Connect other end of supply hose to gun swivel. Use wrenches to tighten all connections securely.

### Installing tip and guard on gun



#### WARNING

1. If equipment has recently been operated, Relieve pressure. Set trigger lock

2. Using a pencil or similar object, Insert seal into back of guard.

3. Install guard over end of gun
4. Insert tip in guard.Tighten retaining nut.

### Operation Spraying

1. Unlock trigger lock
2. Be sure the tip faces forward spray.
3. Hold gun perpendicular and approximately 12 inches (304mm) from surface.Move gun first, Then pull gun trigger to spray a test pattern.
4. Slowly increase pump pressure until coverage is uniform

### Aligning Spray

1. Relieve pressure. Set trigger lock
2. Loosen guard Horizontal Vertical retaining nut
3. Align guard horizontally to spray a horizontal pattern.
4. Align guard vertically to spray a vertical pattern.

## Spray instruction

**CHECK** to ensure that the shipping seal has been removed from under the cap on the hydraulic tank. Hydraulic tank should be at least 3/4 full of hydraulic fluid.

1. During paint spraying, hold the gun upright to the surface of paint-object and keep a constant spraying distance of 350~400mm. (Fig.4)
2. Move gun before starting the trigger. Equably move gun when spraying. At last, loosen the trigger and stop moving immediately. Adjust moving speed according to thickness of paint, spray pressure and the distance of gun to object.
3. In order to get an intact and slick surface, spray from level and vertical respectively. Spraying time will be variable with different paints. Spray for second time when the first painting is dry.

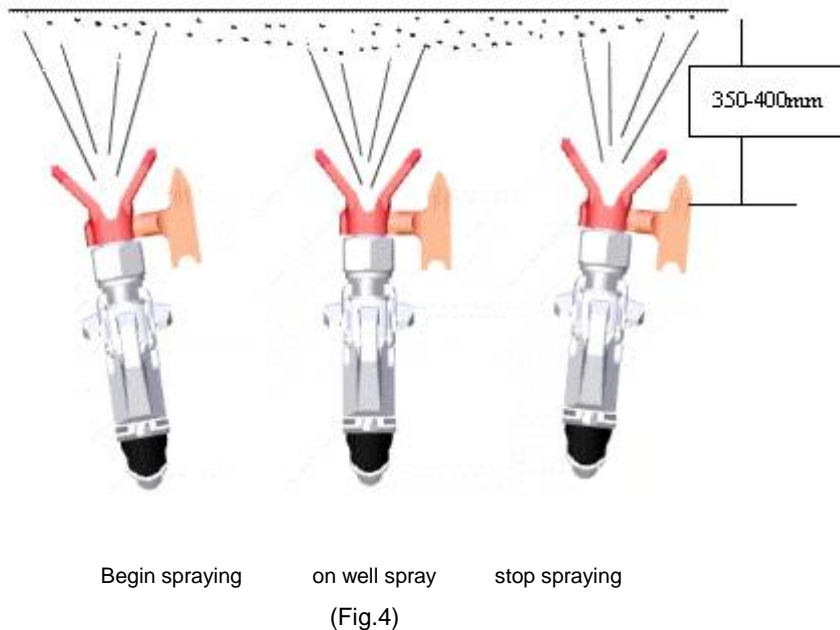

4. During your spraying if you need to stop for several minutes, loosen the pressure valve and revolve prime valve in counter-clockwise, then shut the motor. Put spraying tip into solution in case of paint block-up in the spraying tip.

# Airless Sprayer Cleaning Procedure

When spraying tip is block-up, revolve it 180 degree for several times, then move back in position of well-spraying.



Fig.5

Step 1: Engage trigger safety lock on gun. Revolve 180 degree

Step 2: Turn off pump and release fluid pressure by turning the pressure relief prime valve located on the engage trigger safety lock on gun. side of the pump down.

Step 3: Engage trigger safety lock on gun, Revolve 180 degree then open the safety lock.

## Pressure release procedure

Whenever instructed to relieve pressure, Stop spraying, Check or service equipment or install or clean spray tip.

1. Engage trigger safety lock on gun. Turn Off power and turn sprayer pressure control to lowest pressure setting.
2. Hold gun against side of flushing pail. Trigger gun into pail to relieve pressure.
3. Turn off pump and release fluid pressure by turning the pressure relief prime valve located on the side of the pump down.

## Daily Maintain

Equipment lifetime is rely on daily maintain. The following respects should be obeyed:

1. Read the Manual carefully before first using.
2. Check the electrical requirement before each working.
3. Thorough cleaning equipment and the accessories after using.
4. Coil the tube after cleaning, in case of any damage.
5. Add some lubricant if long time not use

# General Repair Information

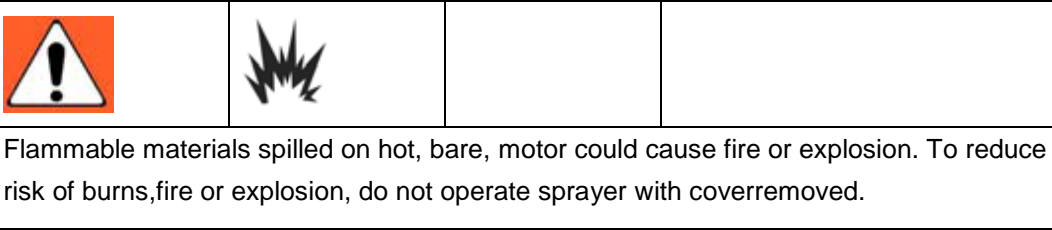
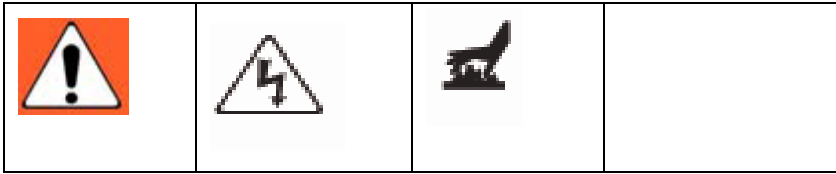

- Keep all screws, nuts, washers, gaskets, and electrical fittings removed during repair procedures. These parts usually are not provided with replacement kits.
- Test repairs after problems are corrected.
- If sprayer does not operate properly, review repair procedure to verify you did it correctly. See **Troubleshooting**, page 8.
- Overspray may build up in the air passages. Remove any overspray and residue from air passages and openings in the enclosures whenever you service sprayer.
- Do not operate the sprayer without the motor shroud in place. Replace if damaged. Motor shroud directs cooling air around motor to prevent overheating and insulates the control board from accidental electric shock.

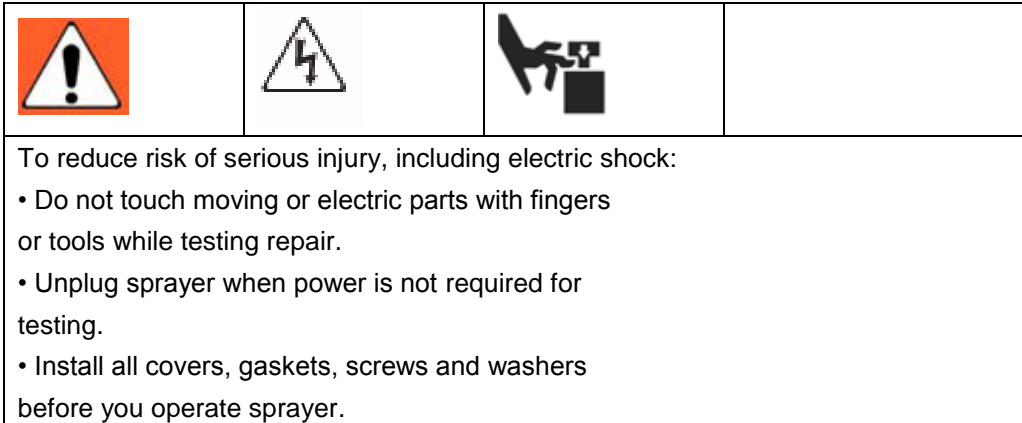

## CAUTION

- Do not run sprayer dry for more than 30 seconds. Doing so could damage pump packings.
- Protect the internal drive parts of this sprayer from water. Openings in the cover allow for air cooling of the mechanical parts and electronics inside. If water gets in these openings, the sprayer could malfunction or be permanently damaged.
- Prevent pump corrosion and damage from freezing. Never leave water or water-base paint in sprayer when its not in use in cold weather. Freezing fluids can seriously damage sprayer. Store sprayer with Pump Armor to protect sprayer during storage.

# Troubleshooting

## 1. Common Problem of Equipment

Problem	What To Check <i>(If check is OK, go to next check)</i>	What To Do <i>(When check is not OK, refer to this column)</i>
<b>Motor Won't Operate</b>		
Basic Fluid Pressure	1. Pressure control knob setting. Motor will not run if set at minimum (fully counter-clockwise).	1. Slowly increase pressure setting to see if motor starts
	2. Spray tip or fluid filter may be clogged.	2. Relieve pressure, then clear clog or clean gun filter
Basic Mechanical	1. Pump frozen or hardened paint	1. Thaw sprayer if water or water-based paint has frozen in sprayer. Place sprayer in warm area to thaw. Do not start sprayer until thawed completely. If paint hardened (dried) in sprayer, replace pump packings.
	2. Displacement pump connecting rod pin. Pin must be completely pushed into connecting rod and retaining spring must be firmly in groove or pump pin.	2. Push pin into place and secure with spring retainer.
	3. Motor. Remove drive housing assembly.	3. Replace motor if fan won't turn.
Low Output	1. Worn spray tip.	1. Relieve pressure, Replace tip
	2. Verify pump does not continue to stroke when gun trigger is released.	2. Service pump.
	3. Prime valve leaking.	3. Relieve pressure, Then repair prime valve.
	4. Suction tube connections	4. Tighten any loose connections. Check o-ring on suction tube.
	5. Electric supply with volt meter. Meter must read 220-240 Vac. Low voltages reduce sprayer performance.	5. Reset building circuit breaker; replace building fuse. Repair electrical outlet or try another outlet.
	6. Extension cord size and length.	6. Replace with a correct, grounded extension cord.
	7. Leads from motor to circuit board for damaged or loose wire connectors. Inspect wiring insulation and terminals for signs of overheating.	7. Be sure male terminal pins are centered and firmly connected to female terminals. Replace any loose terminals or damaged wiring. Securely reconnect terminals.
	8. Worn motor brushes which must be greater than 1/4 in. (6 mm).	8. Replace brushes.
	9. Motor brushes binding in brush holders.	9. Clean brush holders. Remove carbon dust by using compressed air to blow out brush dust.
	10. Low stall pressure. Turn pressure control knob fully clockwise.	10. Replace pressure control assembly.
	11. Motor armature for shorts by using an armature tester (growler) or perform spin test,	11. Replace motor

# Explode view

Issue Date: 2014.06.10  
Version No.: B/0

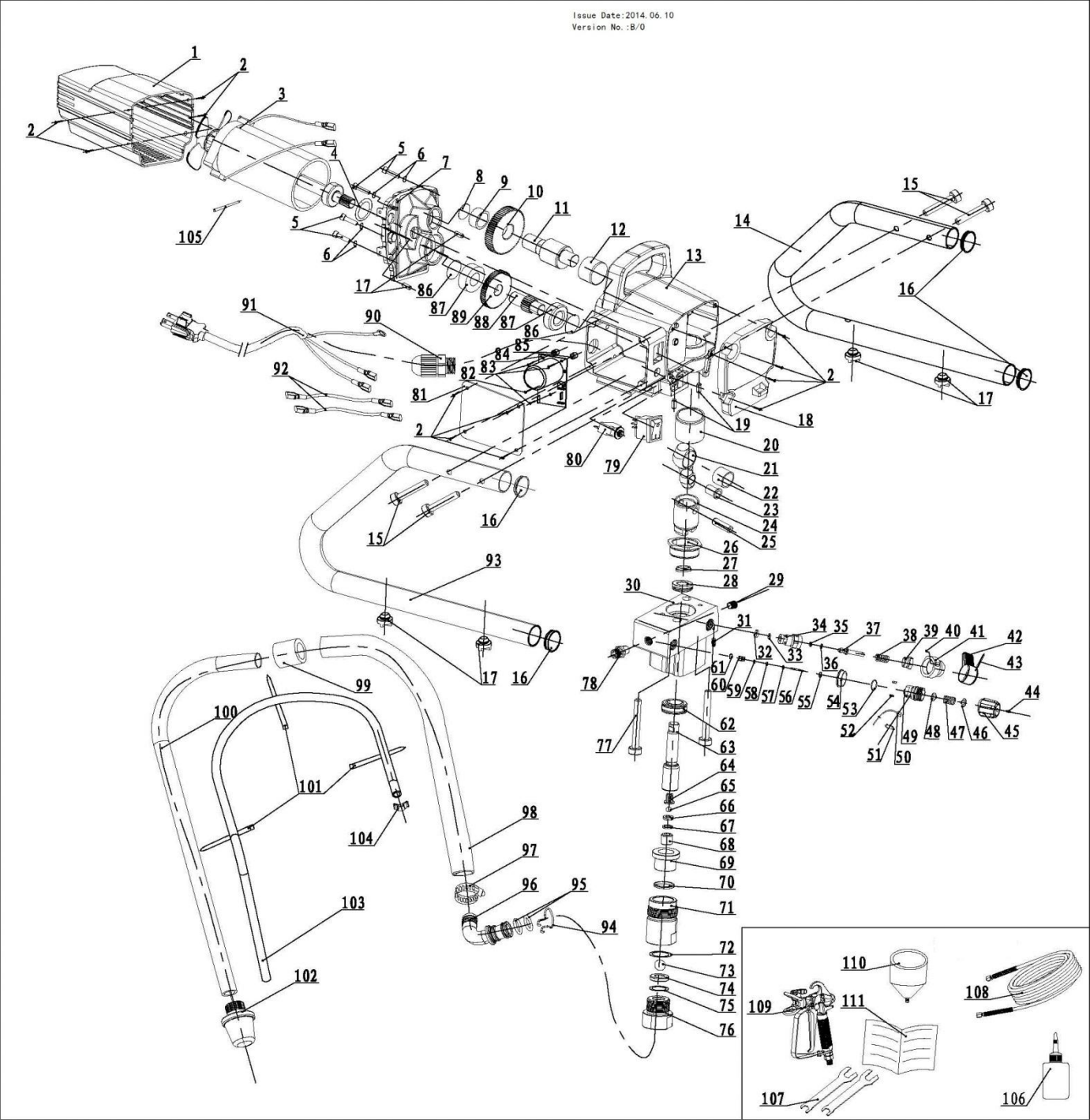



# Parts list

No.	Description	Qty.	No.	Description	Qty.	No.	Description	Qty.
1	Motor cover	1	38	Decompression valve spring	1	75	Valve plates under copper gaskets	1
2	Cross recess head screw (M4X10)	12	39	Spring seat	1	76	Feed base	1
3	Motor assembly	1	40	Elastic cylindrical pin 3X8	1	77	Hexagon socket cap screws	2
4	Wave spring washers	1	41	Switch base	1	78	Discharge joint	1
5	Hexagon socket cap screws (M6X20)	4	42	Switch turn-knob	1	79	Power switch	1
6	Standard spring washer d=6	4	43	Cylindrical pin A2.5 X25	1	80	Overcurrent protector (rated current7A)	1
7	Motor base	1	44	Pressure adjusting screw	1	81	Gear box panel	1
8	Large gear shaft pad	1	45	Regulating sleeve	1	82	Phill small pan head screw	1
9	Needle rooler	1	46	Spring hat	1	83	Phill pan head screw	3
10	Large gear	1	47	Pressure adjusting spring	1	84	Circuit card assembly	1
11	Bent axle	1	48	Deflating cap	1	85	Insulation isolation column	2
12	Needle rooler	1	49	Adjusting base	1	86	Pinion shaft pad	2
13	Gearbox	1	50	Micro switch components(sleeve)	1	87	Single-row radial ball bearing	2
14	Left scaffold	1	51	Micro switch cover	1	88	Pinion	1
15	Hexagon flange bolt M8X45	4	52	Hexagonal socket flat end set screws	2	89	Medium gear	1
16	Armrest framing foot pad	4	53	O-ring (27X2.4)	1	90	Pull-off	1
17	Foot pad	4	54	Cap	1	91	Battery socket	1
18	Gear box cover	1	55	O-ring (8.8X1.9)	1	92	Junction line	2
19	Cylindrical pin	4	56	Switch lever	1	93	Right scaffold	1
20	Piston bush	1	57	Enhanced sealing fin	1	94	Feed pipe bending snap ring	1
21	Linkage	1	58	White seal ring	1	95	O-ring	2
22	Needle rooler	1	59	Lock sleeve	1	96	Feed pipe bending coupler	1
23	Copper bush	1	60	Regulator connection	1	97	Hose clamps(22-32)	1
24	Piston	1	61	O-ring	1	98	Feed hose	1
25	Piston pin	1	62	Large sealing ring components	1	99	Cutting sleeve	1
26	Plunger rod seal lock nut	1	63	Piston rod	1	100	Feed pipe bending	1
27	Plunger rod lock nut liner	1	64	Mouse cage	1	101	Armor tape 3.7x200	3
28	Small sealing ring components	1	65	Little tungsten steel valve ball (Φ8)	1	102	7/8 Filter components	1
29	Hexagonal socket oil plug	1	66	Plunger rod valve plates	1	103	Decompression pipe	1
30	Pump seat	1	67	Mouse cage gasket	1	104	Decompression pipe locking ring components	1
31	Decompression aluminium joint	1	68	Plunger rod valve lock nut	1	105	Armor tape 2.0x100	1
32	Plastic spacer	1	69	Plunger rod guide sleeve	1	106	Oil can	1
33	Screw seat insert	1	70	Rectangular sealing ring	1	107	Open end wrench 17-19	2
34	Decompression valve seat	1	71	Pump body	1	108	High-voltage paint	1
35	Plastic ring	1	72	Copper gasket on the valve plate	1	109	High pressure airless spray gun	1
36	O-ring 5X1.8	1	73	Feed valve ball	1	110	Paint cup	1
37	Decompression valve arm + 4.5tungsten steel ball	1	74	Feed valve plates	1	111	Instruction book	1

# Sealing ring replace:



## Warning

Before the repair, please be sure to determine the equipment fault, otherwise the unnecessary dismantling of equipment will seriously affect the function of the equipment and greatly shorten the service life of equipment.

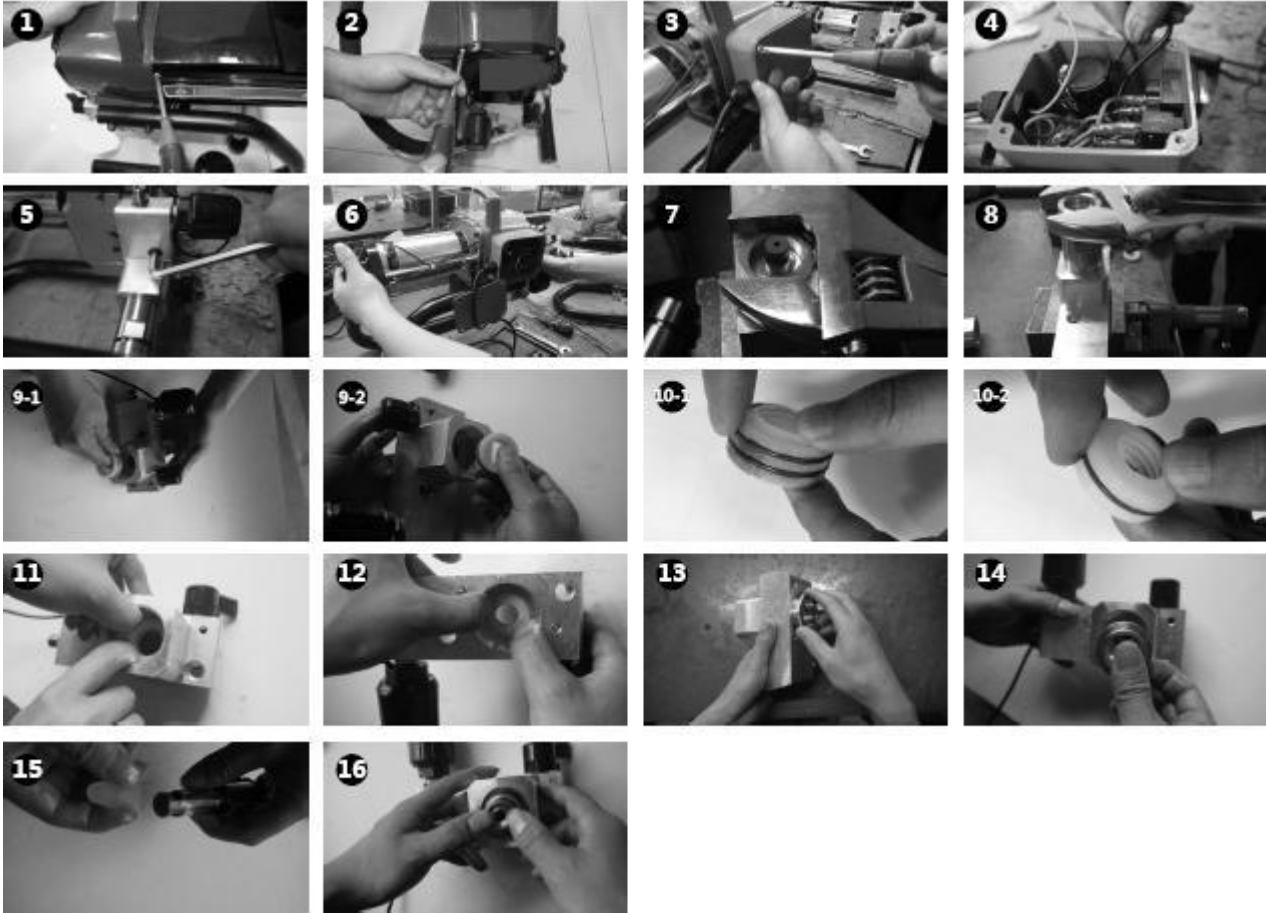

1. With cross screwdriver down pump casing.
2. With cross screwdriver down the cover of a gear box.
3. With cross screwdriver down gear box panel.
4. Find the micro switch line, pulled out the micro switch plug
5. Screw two screw pump under the underside of the socket head
6. Turn the motor cooling blade, remove the pump
7. Screw out the seal lock nut
8. Remove the pump body to
9. Take out the size of the pump seat sealing ring
10. In the size of ring outer ring, with a little grease
11. Pressure the size of the sealing ring into the pump seat
12. Pressure the little ring into the pump seat
13. Seal lock nut screw into the pump
14. Put the plunger guide cap in to pump block .
15. Set the guide sleeve on the plunger rod T head part.
16. Press the plunger rod into sealing ring.
17. In turn, according to remove the installation sequence, install the sprayer.

# R450 Airless Sprayer Electrical Installation Drawing

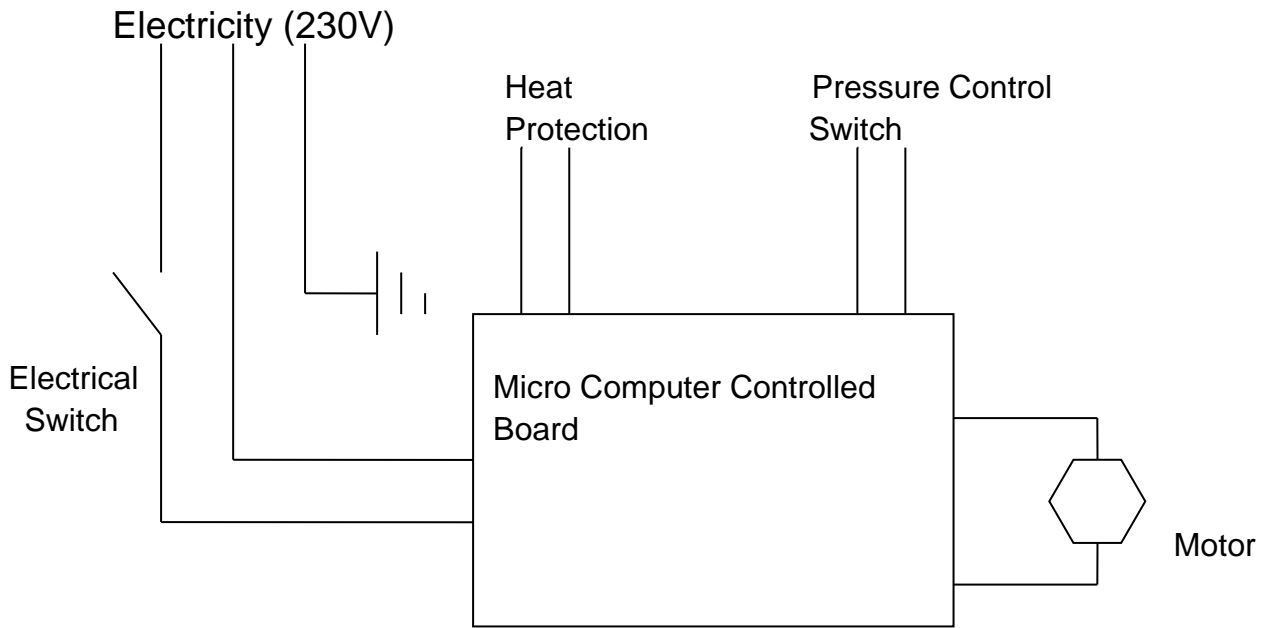

# R455 Airless Sprayer Electrical Installation Drawing

