



**RONGPENG**  
荣鹏气动



## AIRLESS SPRAY GUN

MODEL: 820

- 3600psi (24.8pa) Maximum working pressure
- 4 Finger type lightweight spray gun with 517 reversible spray tip and guard.

### Instructions Manual



<p><b>WARNING</b></p> 	 <p>This manual contains important warnings and information. Read and Keep for reference.</p>
---	--



<p><b>NOTICE</b></p> <p><b>CLEAN IMMEDIATELY</b> Clean the Spray Gun <b>IMMEDIATELY</b> after use. Delayed or inadequate cleaning will permanently clog the Spray Gun.</p>
--



## ◆ Technical Data:

Maximum working pressure	3600Psi(24.8Mpa,248Bar)	Inlet fitting	1/4"-18-NPSM external thread
Operating temperature range	40°to 115°F(4°C to 46°C)	Weight	13.4oz(380g)

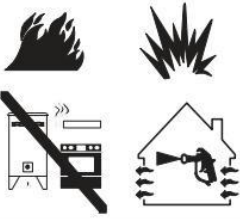
## ◆ Important Safety Instructions:

<b>⚠ WARNING</b>	
	<p><b>FIRE AND EXPLOSION HAZARD</b> Solvent and paint fumes can ignite or explode.</p> <p><b>To help prevent a fire or explosion</b></p> <ul style="list-style-type: none"> <li>• Use outdoors or in a well ventilated area</li> <li>• Avoid all ignition sources such as static electricity from plastic drop cloths, open flames such as pilot lights, hot objects such as cigarettes, and arcs from connecting or disconnecting power cords and turning light switches off or on.</li> <li>• Tape wall switches to prevent them from being turned off or on.</li> <li>• Use only or Graco airless paint hoses.</li> <li>• Ground sprayer, objects being sprayed, and paint/solvent pails.</li> <li>• Hold metal part of gun firmly to side of a grounded metal pail when triggering into pail</li> <li>• Do not use 1,1,1-Trichloroethane, methylene chloride other halogenated hydrocarbon solvents or fluids containing such solvents in this gun or any other pressurized aluminum equipment. Such use could result in a chemical reaction and an explosion.</li> </ul>
	<p><b>FLUID INJECTION HAZARD</b> High-pressure spray or leaks can inject fluid into the body. If high-pressure fluid pierces your skin, the injury might look like "just a cut," but it is a serious wound. Get immediate medical attention.</p> <p><b>To help prevent injection</b></p> <ul style="list-style-type: none"> <li>• Always put gun trigger safety in SAFETY ON position when not spraying.</li> <li>• Always relieve pressure before you check or repair leaks and when you stop spraying.</li> <li>• Never use components rated less than system <i>Maximum Working Pressure</i>.</li> <li>• Never allow children to use this gun.</li> <li>• Never point gun at yourself or anyone else.</li> </ul>
	<p><b>FLUID SPLASHBACK HAZARD</b> To avoid splashback of fluid while spraying, make sure the spray gun is assembled with the correct gasket for the fluid being sprayed. See <b>Installing the Tip</b> on page 4.</p> <p><b>RECOIL HAZARD</b> Brace yourself. The gun may recoil when triggered.</p>

- Do not spray flammable or combustible materials near an open flame, pilot lights or sources of ignition such as hot objects, cigarettes, motors, electrical equipment and electrical appliances. Avoid creating sparks from connecting and disconnecting power cords.
- For units intended for use with only water-based or mineral spirit-type materials with a minimum flash point of 38°C (100°F) — Do not spray or clean with liquids having a flash point of less than 38°C (100°F). Flash point is the temperature at which a fluid can produce enough vapor to ignite.
- Use extreme caution when using materials with a flashpoint below 100°F (38°C). **Refer to your pump manual to determine if these materials can be sprayed.**
- Paint or solvent flowing through the equipment is able to result in static electricity. Static electricity creates a risk of fire or explosion in the presence of paint or solvent fumes. All parts of the spray system, including the pump, hose assembly, spray gun and objects in and around the spray area shall be properly grounded to protect against static discharge and sparks. Use only conductive or grounded high-pressure airless paint sprayer hoses specified by the manufacturer.
- Verify that all containers and collection systems are grounded to prevent static discharge.
- Connect to a grounded outlet and use grounded extension cords (electric models only). Do not use a 3 to 2 adapter.
- Do not use a paint or solvent containing halogenated hydrocarbons. Such as chlorine, bleach mildewcide, methylene chloride and trichloroethane. They are not compatible with aluminum. Contact the coating supplier about compatibility of material with aluminum.
- Keep spray area well ventilated. Keep a good supply of fresh air moving through the area to keep the air within the spray area free from accumulation of flammable vapors. Keep pump assembly in well ventilated area. Do not spray pump assembly.
- Do not smoke in the spray area.
- Do not operate light switches, engines, or similar spark producing products in the spray area.
- Keep area clean and free of paint or solvent containers, rags, and other flammable materials.
- Know the contents of the paint and solvents being sprayed. Read all Material Safety Data Sheets (MSDS) and container labels provided with the paints and solvents. Follow the paint and solvent manufacture's safety instructions.
- Place pump at least 25 feet (7.62 meters) from the spray object in a well ventilated area (add more hose if

necessary). Flammable vapors are often heavier than air. Floor area must be extremely well ventilated. The pump contains arcing parts that emit sparks and can ignite vapors.

- Plastic can cause static sparks. Never hang plastic to enclose spray area. Do not use plastic drop cloths when spraying flammable material.
- Fire extinguisher equipment shall be present and working.



#### **WARNING: INJECTION INJURY**

A high pressure paint stream produced by this equipment can pierce the skin and underlying tissues, leading to serious injury and possible amputation. See a physician immediately.

- Do not aim the gun at, or spray any person or animal.
- Keep hands and other body parts away from the discharge. For example, do not try to stop leaks with any part of the body.
- NEVER put your hand in front of the gun. Gloves will not provide protection against an injection injury.
- ALWAYS keep the tip guard in place while spraying. The tip guard provides some protection but is mainly a warning device.
- Only use a nozzle tip specified by the manufacturer.
- Use caution when cleaning and changing nozzle tips. In the case where the nozzle tip clogs while spraying, ALWAYS lock gun trigger, shut pump off, and release all pressure before servicing, cleaning tip or guard, or changing tip. Pressure will not be released by turning off the motor. The PRIME/SPRAY valve or pressure bleed valve must be turned to their appropriate positions to relieve system pressure. Refer to PRESSURE RELIEF PROCEDURE described in the pump manual.
- Do not leave the unit energized or under pressure while unattended. When the unit is not in use, turn off the unit and relieve the pressure in accordance with the manufacturer's instructions.
- High-pressure spray is able to inject toxins into the body and cause serious bodily injury. In the event that injection occurs, seek medical attention immediately.
- Check hoses and parts for signs of damage, a leak can inject material into the skin. Inspect hose before each use. Replace any damaged hoses or parts. Only use TITAN original-high-pressure hoses in order to ensure functionality, safety and durability.
- This system is capable of producing 3600psi / 248 Bar. Only use replacement parts or accessories that are specified by the manufacturer and that are rated a minimum of 3600 PSI. This includes spray tips, nozzle guards, guns, extensions, fittings, and hose.
- Always engage the trigger lock when not spraying. Verify the trigger lock is functioning properly.
- Verify that all connections are secure before operating the unit.
- Know how to stop the unit and bleed pressure quickly. Be thoroughly familiar with the controls. Pressure will not be released by turning off the motor. The PRIME/SPRAY valve or pressure bleed valve must be turned to their appropriate positions to relieve system pressure. Refer to PRESSURE RELIEF PROCEDURE described in the pump manual.
- Always remove the spray tip before flushing or cleaning the system.

#### **NOTE TO PHYSICIAN:**

**Injection into the skin is a traumatic injury which can lead to possible amputation. It is important to treat the injury as soon as possible. DO NOT delay treatment to research toxicity. Toxicity is a concern with some coatings injected directly into the blood stream. Consultation with a plastic surgeon or reconstructive hand surgeon may be advisable.**



#### **WARNING: GENERAL**

Can cause severe injury or property damage.

- Always wear appropriate gloves, eye protection, clothing and a respirator or mask when painting.
- Do not operate or spray near children. Keep children away from equipment at all times.

- Do not overreach or stand on an unstable support. Keep effective footing and balance at all times.
- Stay alert and watch what you are doing.
- Do not operate the unit when fatigued or under the influence of drugs or alcohol.
- Do not kink or over-bend the hose. Airless hose can develop leaks from wear, kinking and abuse. A leak can inject material into the skin.
- Do not expose the hose to temperatures or pressures in excess of those specified by manufacturer.
- Do not use the hose as a strength member to pull or lift the equipment.
- Use lowest possible pressure to flush equipment.
- Follow all appropriate local, state and national codes governing ventilation, fire prevention and operation.
- Before each use, check all hoses for cuts, leaks, abrasion or bulging of cover. Check for damage or movement of couplings. Immediately replace hose if any of those conditions exist. Never repair a paint hose. Replace with a conductive high-pressure hose.
- Do not spray outdoors on windy days.
- Always unplug cord from outlet before working on equipment (electric models only).

### ◆ Instructions For Operation



#### ➤ Using the Gun Trigger Lock

Always engage the gun's trigger lock when the gun is not in use(1).

1. To lock the trigger, rotate the trigger lock backward until it stops(2).
2. To unlock the trigger, rotate the trigger lock forward until it is vertical(3).

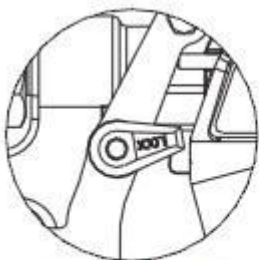
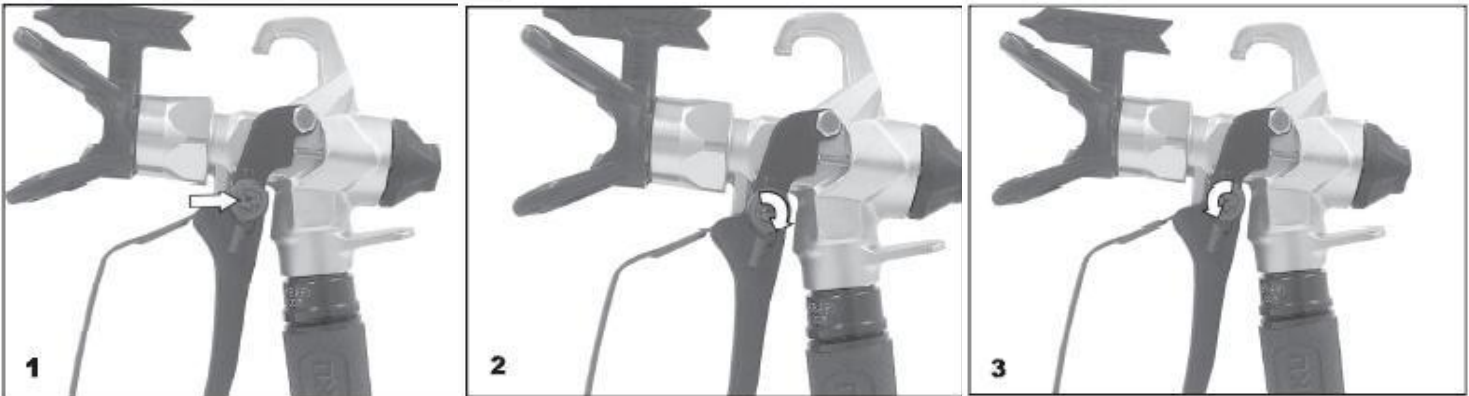

Trigger locked  
(gun will not spray)



Trigger unlocked  
(gun will spray)



## ➤ Setup



Never attempt to assemble, change, or clean the gun, tip, or tip guard without first relieving pressure from the spray system. Follow the “Pressure Relief Procedure” in the sprayer’s Manual.



Always use a tip safety guard for added protection against injection. Beware that the guard alone will not prevent injection. Never cut off tip guard! Always engage gun trigger lock when the gun is not in use. Before servicing equipment, consult Owner’s Manuals and follow all warnings.

1. Set up the sprayer. Refer to the instructions in the sprayer’s Manual.
2. Attach a grounded, airless spray hose to the material inlet on the gun. Using two wrenches (one on the gun and one on the hose), tighten securely(4).

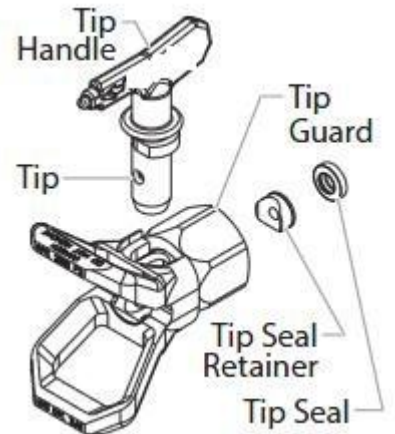
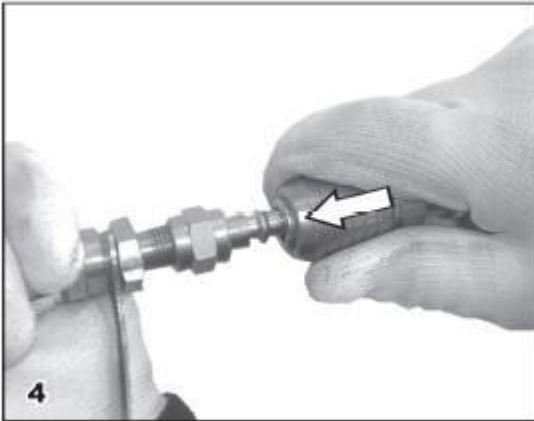

3. With the tip and tip guard off the gun, start the sprayer. Flush and prepare the spray system according to the sprayer’s Owner’s Manual. Inspect the spray system to make sure that all fittings are secure and that there are no leaks.
4. Perform the “Pressure Relief Procedure” described in the sprayer’s Owner’s Manual.
5. Using the arrow head on the tip handle, insert the tip seal and tip seal retainer into the back of the tip guard(5). Press in for final adjustment.
6. Insert the tip into the slot on the tip guard(6).

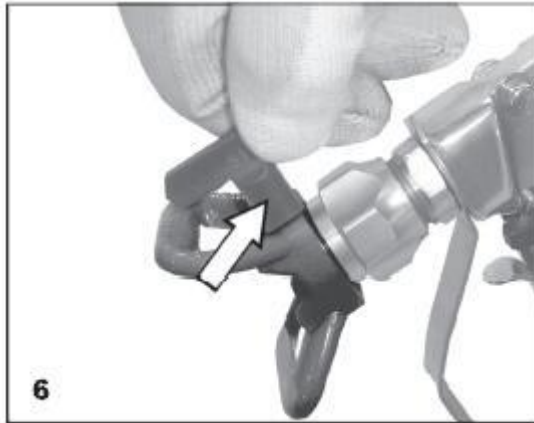
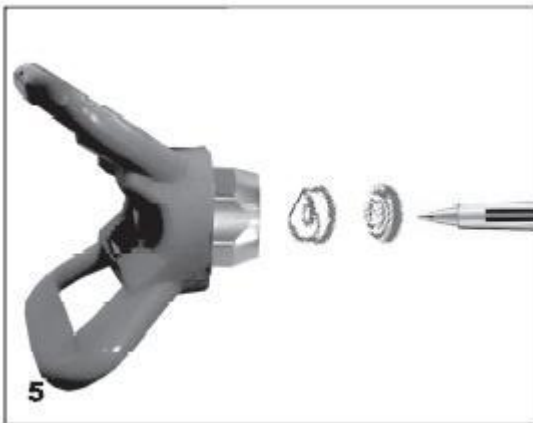

7. Thread the tip guard onto the gun. Position the tip guard in the desired spraying position and tighten securely.  
**NOTE: The arrow on the tip handle should be pointing in the forward direction for spraying.**

## ➤ Operation

1. Make sure the arrow on the tip handle is pointing in the forward direction for spraying.
2. Start the sprayer. Refer to the instructions in the sprayer’s Manual.
3. Adjust the fluid pressure on the sprayer until the spray is completely atomized. Always spray at the lowest pressure necessary to get the desired results.  
**NOTE: The spray tip determines the size of spray pattern and coverage. When more coverage is needed, use a larger tip instead of increasing fluid pressure.**
4. To clear a clogged tip:

a. Rotate the tip 180° so that the arrow on the tip handle is pointing opposite the spray direction.(7)

b. Trigger the gun once so that the pressure can blow the clog out.

**Important: Never pull the trigger more than once at a time with the tip in the reverse position.**

c. Continue this procedure until the tip is clear of the clog.

#### ➤ Changing a Tip

Tips can be removed and replaced easily without disassembling the gun.



**Never attempt to change or clean the tip or tip guard without first performing the “Pressure Relief Procedure.”**

1. Perform the “Pressure Relief Procedure” described in the sprayer’s Manual.

2. Remove the tip from the slot on the tip guard.

3. Insert the new tip into the slot on the tip guard. The arrow on the tip handle should be pointing in the forward direction.

#### ➤ Removing the Seal and Tip Seal

1. Remove the tip and tip guard from the spray gun.

2. Remove the seal and tip seal from the back of the tip guard(8).

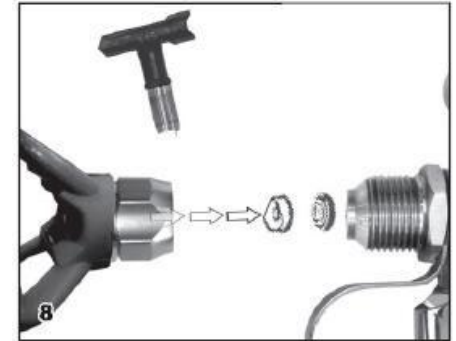

#### Identifying Tip Sizes

To identify tip sizes, use the following formula. A “517” tip size will be used in this example.

The first digit multiplied by two represents the size of the spray pattern when spraying 12”(30cm) away from the work surface:  $5 \times 2 = 10$ ” spray pattern

The second two digits represent the diameter of the orifice on the tip:  $17 = .017$ ”(0.43mm) orifice

#### NOTE:

**Worn spray tips will adversely affect the spray pattern and result in reduced production, poor finish, and wasted material. Replace worn tips immediately.**

#### ➤ Cleanup

Maintaining a clean gun is important to ensure trouble-free operation. Flush the gun after each use and store in a dry location. Do not leave the gun or any of its parts in water or solvents.



**Special cleanup instructions for use with flammable solvents:**

- Always flush spray gun preferably outside and at least one hose length from spray pump.
- If collecting flushed solvents in a one gallon metal container, place it into an empty five gallon container, then flush solvents.
- Area must be free of flammable vapors.
- Follow all cleanup instructions.

**Important: The sprayer, hose, and gun should be cleaned thoroughly after daily use. Failure to do so permits material to cake, seriously affecting the performance of the unit.**



Always spray at minimum pressure with the tip and tip guard removed when using mineral spirits or any other solvent to clean the sprayer, hose, or gun. Static electricity buildup may result in a fire or explosion in the presence of flammable vapors. Hold the gun firmly against a metal container while flushing.

#### ◆ Maintenance



Follow all safety precautions as described in the Safety Precautions section of this manual before proceeding.

**NOTE: Refer to the Parts List section in this manual for part identification.**

#### ➤ Replacing/Serviceing the Seal Assembly

If your spray gun leaks or spits at the tip when you release the trigger, the needle or seat is worn, damaged, or dirty and must be replaced or cleaned.



**Never attempt to perform maintenance on the spray gun without first performing the “Pressure Relief Procedure.”**

1. Perform the “Pressure Relief Procedure” and disconnect the fluid hose from the gun.
  2. Remove the end cap and the packing spring from the rear of the gun head.
  3. Using a 3/8” socket, remove the packing seal assembly from the rear of the gun head.
  4. Soak the removed parts in the appropriate solvent and wipe clean.
  5. Inspect the parts for wear or damage and use new parts during reassembly of the gun, when necessary.
- NOTE: Lubricate all packings and moving parts before reassembly with a lithium-based grease.
6. Make sure the two retractor pins inside the gun head are still in the correct position.
  7. Insert the packing seal assembly into the rear of the gun head and thread it by hand until it stops.
  8. Using a 3/8” socket, tighten the packing seal assembly. Torque to 5 Nm (3.7 ft./lbs.).
  9. Grease both ends of the packing spring and place it over the packing seal assembly in the gun head.
  10. Place the end cap over the packing spring so that the pilot inside the end cap seats inside the packing spring.
  11. Push the end cap toward the gun head while threading it into the gun head. Using a wrench, tighten the end cap securely.
  12. Perform the “Adjusting the Packing Seal Assembly” procedure described below.

➤ **Adjusting the Packing Seal Assembly**



Proper adjustment of the seal assembly is essential to ensure positive shut-off when the trigger is released.

1. Insert an 1/8” hex wrench through the hole in the center of the end cap until it seats inside the packing seal adjustment screw.
2. Turn the packing seal adjustment screw clockwise until the ball on the packing seal assembly can be felt seating into position. Then, turn the screw 1/4 turn more for proper tension.

➤ **Replacing/Removing the Filter**

1. Pull the bottom of the trigger guard forward so that it comes loose from the handle assembly(9).
2. Loosen and remove the handle assembly from the gun head(10).
3. Pull the old filter out of the gun head(11).
4. Slide the new filter, tapered end first, into the gun head(12).
5. Make sure all the parts are clean and the handle seal is in position inside the gun head.
6. Thread the handle assembly into the gun head until secure.
7. Snap the trigger guard back onto the handle assembly.

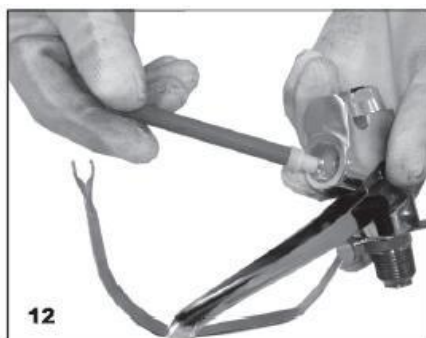
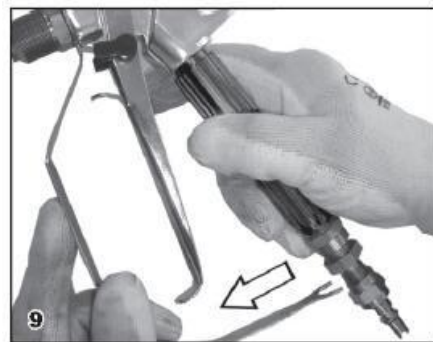

# Explosive View and Parts list

Issue date: 2014. 04. 16

Version no.: V1

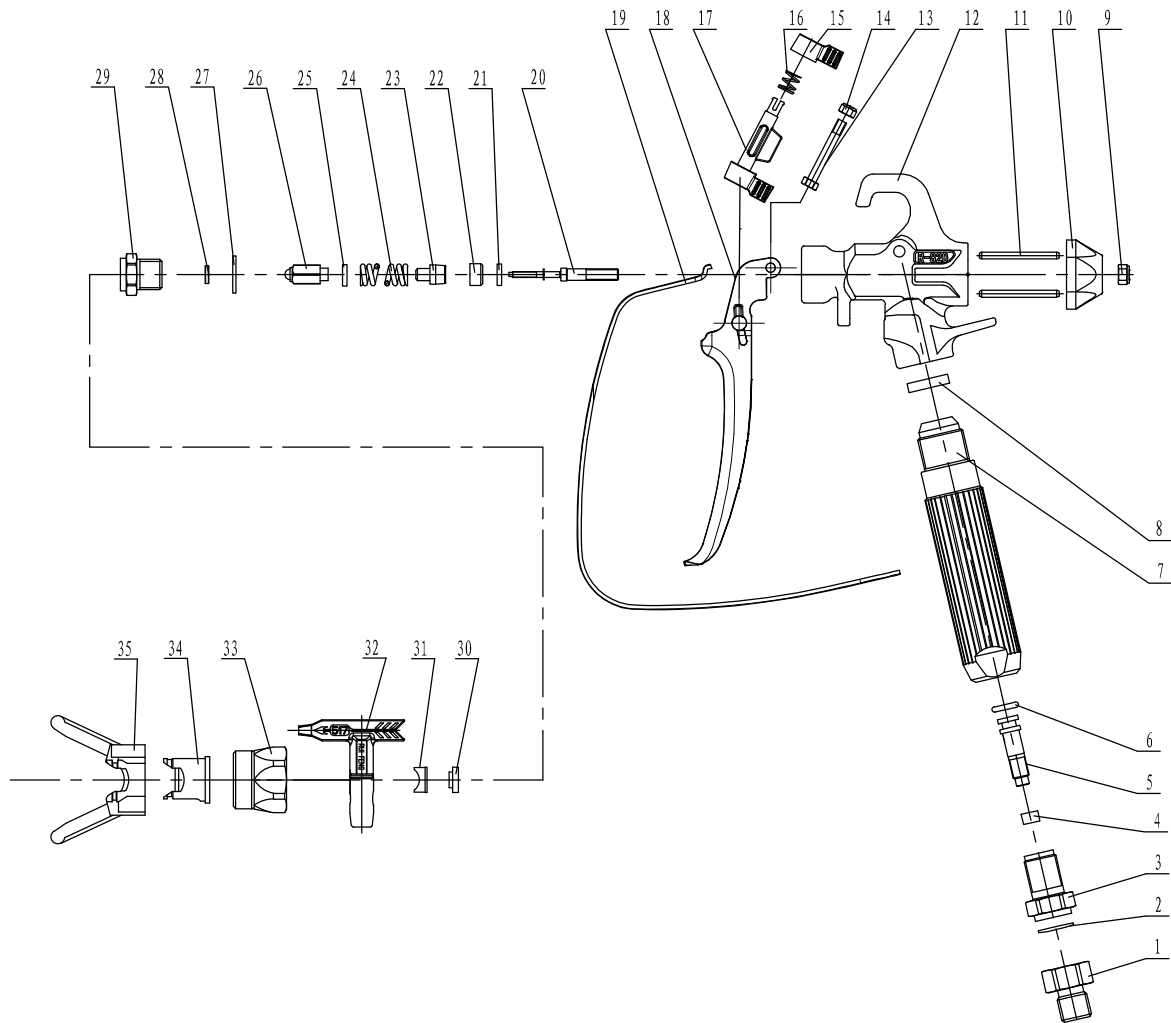

No.	Figure number	Description	Qty.	No.	Figure number	Description	Qty.
1	03. 01. 01. 085. 001	Material inlet connection	1	19	03. 01. 01. 085. 009	Tigger guard	1
2	03. 01. 01. 018. 015	Washer	1	20	03. 01. 01. 018. 005	Thimble	1
3	03. 01. 01. 085. 002	Material inlet joint	1	21	03. 01. 01. 018. 008	Copper washer	1
4	03. 01. 01. 041. 006	Interval washer	1	22	03. 01. 01. 018. 007	Thimble sealing washer	1
5	03. 01. 01. 085. 003	Material connection core	1	23	03. 01. 01. 085. 010	Spring core	1
6	03. 05. 01. 248	O-ring 6*2	1	24	03. 01. 01. 018. 004	Thimble spring	1
7	03. 01. 01. 018. 068-01	Handle	1	25	03. 01. 01. 018. 0054	Thimble head washer	1
8	03. 01. 01. 018. 052	Washer	1	26	05. 01. 48. 17. 002	Thimble head assembly	1
9	03. 05. 08. 039	Locked nut M5	1	27	03. 01. 01. 018. 053	Washer	1
10	03. 01. 01. 085. 004	Switch seat	1	28	03. 01. 01. 085. 011	Plug insert	1
11	03. 01. 01. 018. 046	Switch pin	2	29	03. 01. 01. 085. 012	Plug seat	1
12	03. 01. 01. 085. 005	Gun body	1	30	03. 01. 01. 018. 044	Rubber plug	1
13	03. 05. 11. 017	Hex bolt M4*30	1	31	03. 01. 01. 018. 043	Nozzle cap	1
14	03. 05. 08. 038	Nut M4	1	32	03. 01. 01. 041. 012-02	Reversible Tip assembly	1
15	03. 01. 01. 085. 006	Trigger pole joint	1	33	03. 01. 01. 018. 042-01	Nut	1
16	03. 01. 01. 018. 051	Spring	1	34	03. 01. 01. 018. 058	Tip seat	1
17	03. 01. 01. 085. 007	Trigger pole	1	35	03. 01. 01. 018. 067-04	Tip Guard	1
18	03. 01. 01. 085. 008	Trigger	1				

Note: If you need spare parts of this model, pls feel free to contact us or the distributor where you bought this tool. Tks!